

Article number: 2310308231ESD

Description: E+G Antistatic base for levelling elements
LV.A-80-14-AS-M10x98-ESD-C

Measures

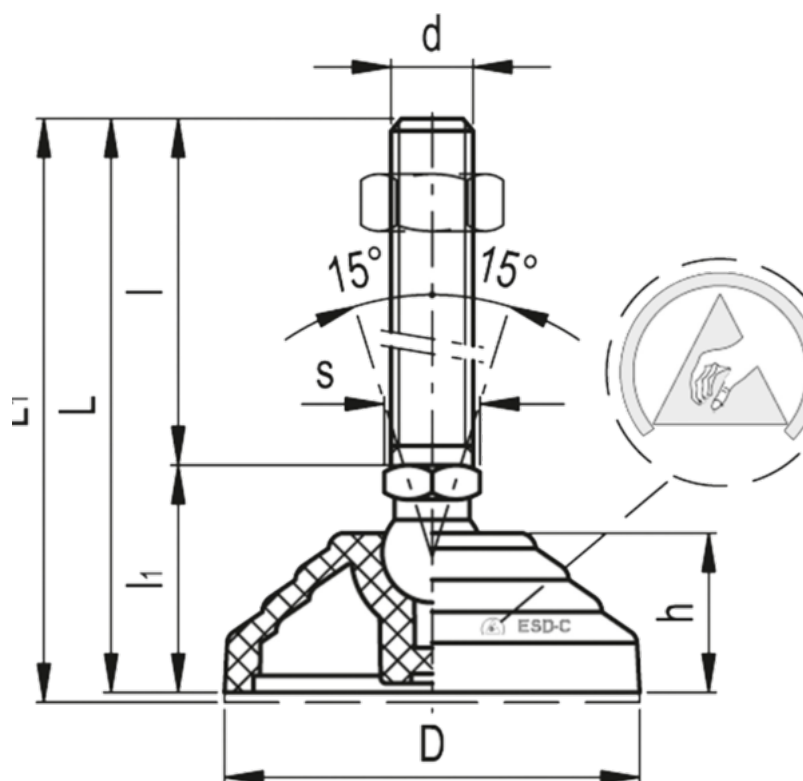

Articulation	= 14	Max load	= 16000
D	= 80	s	= 14
d	= M10	Weight in (g)	= 144
h	= 24		
l	= 98		
l1	= 33		
L	= 131		
L1	= 134		